

6000
1.353 kg/mt

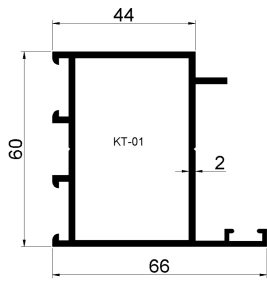

6001
1.360 kg/mt

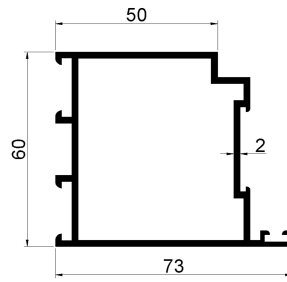

6002
1.478 kg/mt

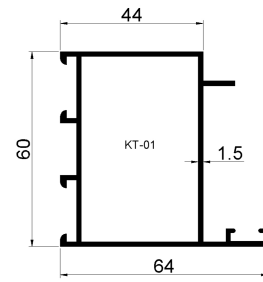

6003
1.069 kg/mt

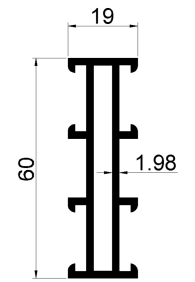

6004
0.978 kg/mt

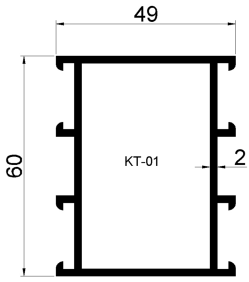

6005
1.300 kg/mt

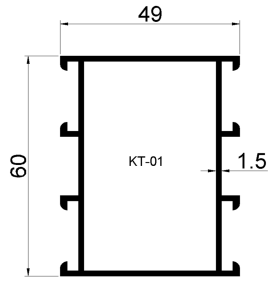

6006
1.030 kg/mt

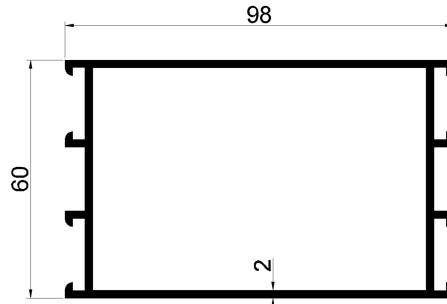

6007
1.824 kg/mt

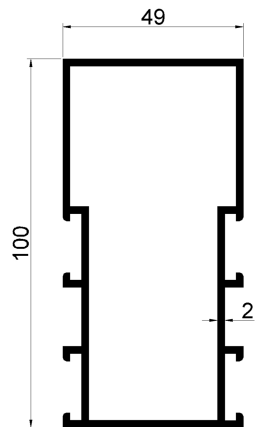

6008
1.806 kg/mt

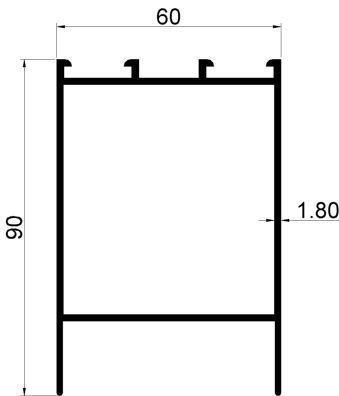

6009
1.496 kg/mt

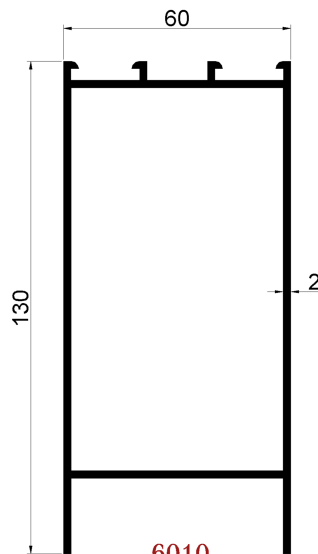

6010
2.100 kg/mt

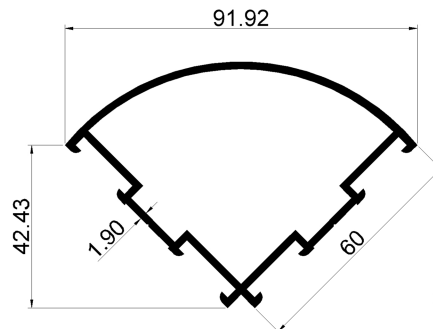

6011
1.365 kg/mt

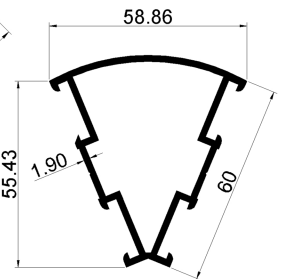

6012
1.145 kg/mt

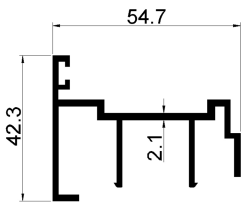

6016
0.868 kg/mt

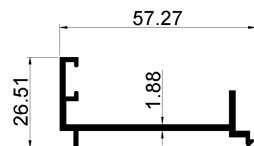

6017
0.506 kg/mt

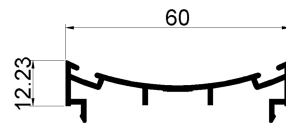

6013
0.465 kg/mt

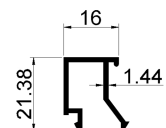

6014
0.243 kg/mt

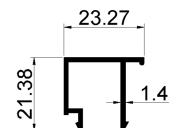

6015
0.257 kg/mt

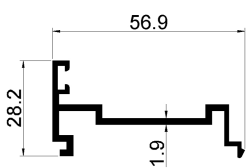

6020
0.568 kg/mt

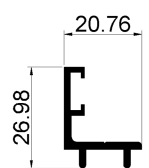

6021
0.298 kg/mt

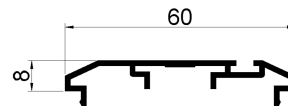

6018
0.423 kg/mt



6019
0.495 kg/mt

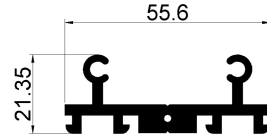

6022
1.043 kg/mt



6023
0.430 kg/mt

C60 SYSTEM

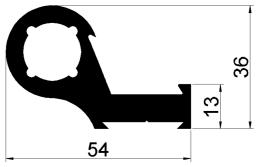

6024
1.768 kg/mt

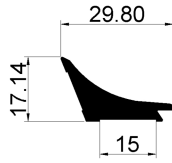

6025
0.471 kg/mt

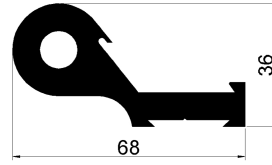

6026
2.450 kg/mt

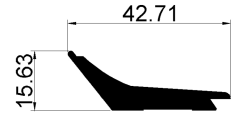

6027
0.606 kg/mt

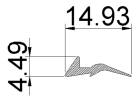

FT-15

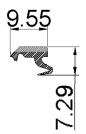

FT-16

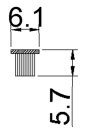

FT-17

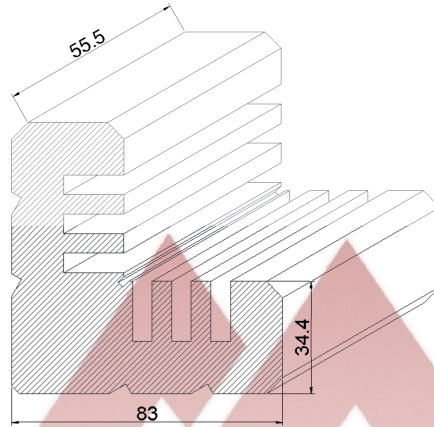

6028 (KT-01)
10.205 kg/mt

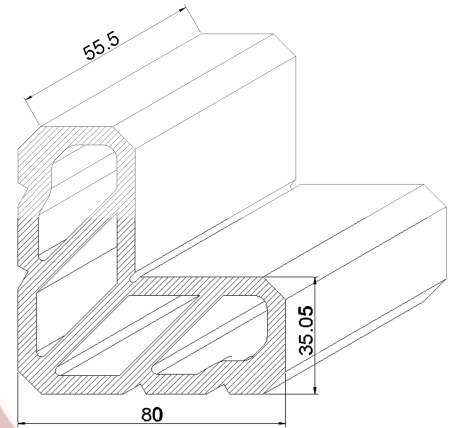

6029 (KT-01)
6.000 kg/mt

C50 SYSTEM

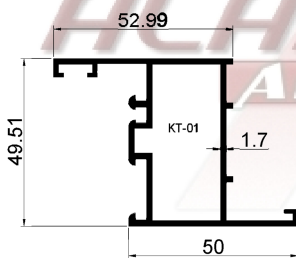

5000
1.080 kg/mt

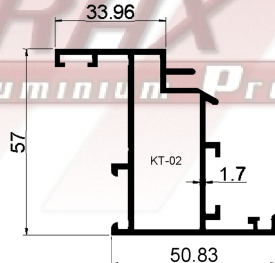

5001
1.203 kg/mt

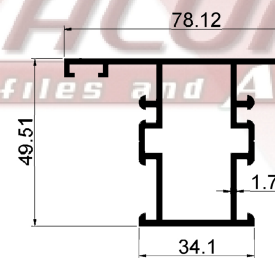

5002
1.242 kg/mt

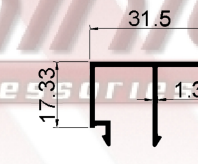

5003
0.284 kg/mt

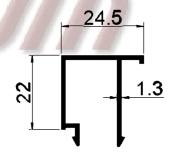

5004
0.292 kg/mt

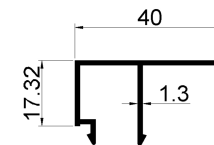

5005
0.312 kg/mt

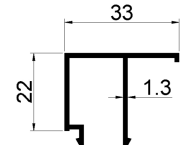

5006
0.320 kg/mt

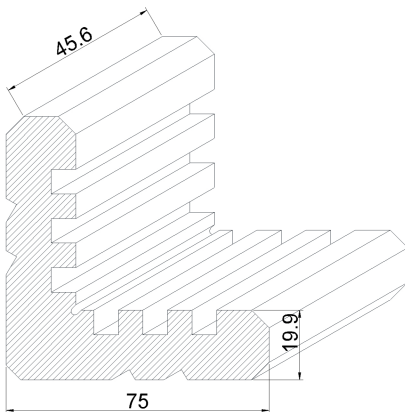

5007 (KT-01)
5.938 kg/mt

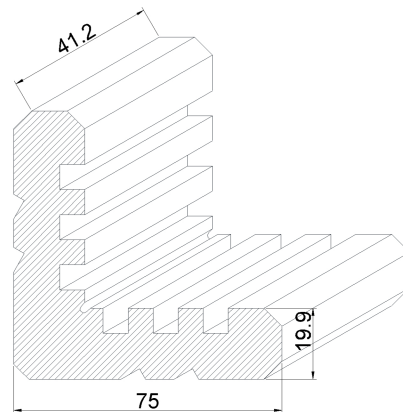

5008 (KT-02)
5.938 kg/mt

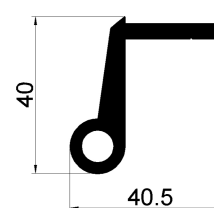

5009
0.946 kg/mt



5010
0.721 kg/mt